

On the effect of adjacent sector Multiple Access Interference on Space Time Spreading Systems

Peter James Vial, Ibrahim Raad , Tad Wysocki

University of Wollongong, School of Electrical Computer and Telecommunications Engineering

Email:

Peter.Vial@uow.edu.au, Ibrahim.Raad@uow.edu.au, Tad.Wysocki@uow.edu.au,

Abstract

Space Time Spreading systems are proposed as a method to enhance communications between the Base Station (BS) and Mobile Station (MS) by using multiple transmit antennas at the Base Station. This provides a form of transmit diversity when there are more than one transmitting antennas. Space Time Spreading systems have been shown to be efficient in their use of the limited number of orthogonal spreading sequences and to provide a diversity gain, which in the case of two transmitter antennas at the BS and one receiving antenna at the MS, is of order two. The paper looks at the effect of unsynchronized adjacent cell interference caused by scatterers causing the target MS to experience Multiple Access Interference (MAI) due to mis-aligned orthogonal codes from adjacent sectors in a sectorised cell (with 120 degree sectorisation). The study finds that adjacent MAI does adversely influence the Bit Error Rate (BER) of the target MS.

Keywords : Code Division Multiple Access (CDMA), Space Time Spreading, Mobile Station, Transmit Diversity, Simulink, Walsh codes, Adjacent Multiple Access Interference (MAI), SDMA

1.0 Introduction

In [1] Hochwald et al. propose a novel transmit diversity technique which they named Space Time Spreading. This technique is classified as an open loop transmit diversity system in that there is no knowledge at the transmitter, received from the reverse link, about the quality of the channel between the transmitter and the receiver. This information is only needed at the receiver, and estimates of the complex channel coefficients can be found from the associated pilot signals sent by the BS to the MS. In [1] Space Time Spreading systems were shown to be efficient in their use of the limited number of orthogonal spreading sequences and to provide a diversity gain, which in the case of two transmitter antennas at the BS and one receiving antenna at the MS, is of order two. They also describe the more general case of having multiple antennas at the transmitter (BS) and the receiver (MS). The technique requires that the antennas be uncorrelated, which means in practice that the antennas should be at least ten wavelengths apart [2] [3].

Having a diversity gain means that if one path is in a very deep fade, it is unlikely that the other path will also be in a very deep fade and the system would then default back to a single diversity system [1]. This system also moves away from diversity gains that would occur through temporal factors such as mobility between the BS and MS. Wireless LANs are one of the expected application areas of Space Time Spreading systems. Wireless LAN based networks will have low or no motion between the

transmitter and receiver(s) involved. Further, it is probable that Space Division Multiple Access systems would be deployed using sectorised cells for each Access Point. The MAC (Multiple Access Control) technique used would thus be a combination of SDMA and CDMA [4]. A common use for Wireless LANs is to provide communications between a computer using wireless in an office or lecture theatre and a fixed Access Point (BS). There is low to no relative motion in this case. This then does not allow for gains in diversity that can be obtained via the use of temporal factors as often used in the literature (such as coding and interleaving – as stated in [1]). Space Time Spreading systems do not depend on such diversity techniques and thus have a major potential advantage in this segment of the wireless communications market.

Space Division Multiple Access (SDMA) can be used with CDMA systems by sectorising the cells within which different users may be located. For example, a cell can be split into three segments divided into 120 degree arcs as shown in Figure 1. With mobile scatterers being placed within these sectors it is possible for signals from one sector to be reflected or scattered into adjacent sectors. This is expected to cause the orthogonal codes used to separate signals to become unsynchronized and to result in Multiple Access Interference (MAI).

This paper is organised as follows, first we describe the algorithm used in the Space Time Spreading system which complies with the one given in [1]. This is followed by a description of

how this system is modeled in the MATLAB Simulink modelling language. The results of validation experiments are then described for BPSK (Binary Phase Shift Keying) transmission. Then we describe a scenario which introduces MAI from communications to another MS in an adjacent sector. Conclusions are then provided and possible areas for future research are outlined.

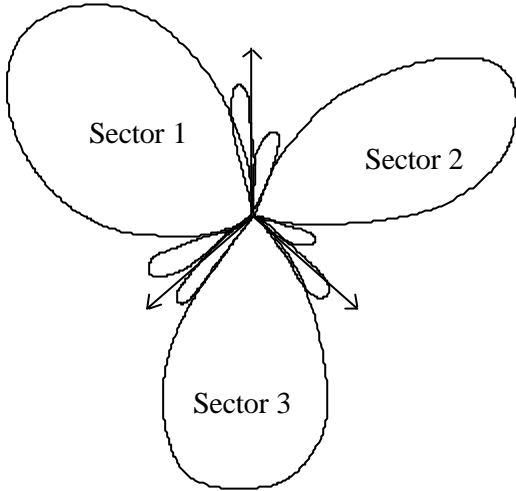

Figure 1: A cell sectorised into three 120 degree segments [5]

2.0 Space Time Spreading

The Space Time Spreading system that this study looks at is the case where there are two transmit antennas (at the BS) and one receive antenna (at the MS). The Space Time Spreading scheme starts by separating a bit stream into odd and even symbols, identified as b_1 and b_2 . These are then radiated by two antennas as follows:

$$\begin{aligned} t_1 &= (1/\sqrt{2})(b_1c_1 + b_2c_2) \\ t_2 &= (1/\sqrt{2})(b_2c_1 - b_1c_2) \end{aligned} \quad (1)$$

where c_1 and c_2 are the orthogonal spreading codes with processing gain equal to their length. In this study the length of the orthogonal codes was chosen as 128 chips. The constant $1/\sqrt{2}$ is used to normalize the power for comparison to a single antenna system. Figure 2 shows, in a block diagram form, the Space Time Spreading technique for two antennas as described by Equation 1.

The radiated signals are transmitted through the channel to one receiver antenna, each path experiencing a different complex flat fading coefficient or gain (since they are uncorrelated). They are faded using a Rayleigh probability density function (pdf) with unity mean and the uniform phase distributed between zero and 2π .

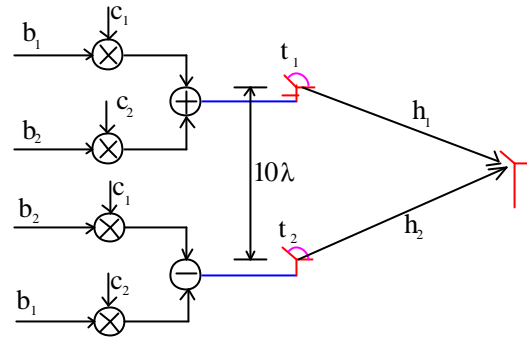

Figure 2: The block diagram of a Space Time Spreading system [1] considered in this paper.

The received signal at the target MS is then despread by the two orthogonal codes. In [1], the following notation is used:

$$\underline{d} = \begin{bmatrix} d_1 \\ d_2 \end{bmatrix} = [d_1 \quad d_2]^T \quad (2)$$

and

$$H = \begin{bmatrix} h_1 & h_2 \\ -h_2 & h_1 \end{bmatrix} \quad \underline{b} = \begin{bmatrix} b_1 \\ b_2 \end{bmatrix} \quad \underline{n} = \begin{bmatrix} c_1^H \underline{n} \\ c_2^H \underline{n} \end{bmatrix} \quad (3)$$

where $(\bullet)^H$ stands for the Hermitian transpose and \underline{n} is a 128 by 1 vector of additive zero mean complex Gaussian noise samples. Using this notation the received signal vector \underline{d} can be expressed as:

$$\underline{d} = \frac{1}{\sqrt{2}} H \underline{b} + \underline{n} \quad (4)$$

Further, it is shown [1] that if h_q represents the q^{th} column of H (in this case $q=1$ or 2 only) then the following is true:

$$\Re\{e^{j\theta} \underline{d}\} = (1/\sqrt{2})(|h_1|^2 + |h_2|^2) b_q + \Re\{e^{j\theta} \underline{d}\} \quad (5)$$

It is then a simple matter to use this to decode the received signal for either b_1 or b_2 using Equation 5 and knowing the channel coefficients and hence the H matrix at the receiver. In [1] they note that this has the required two-fold diversity gain, expected for this system.

3.0 Description of SIMULINK model

The Simulink model consists of a series of sub systems which are modeled in Simulink and presented in Figure 3. For the validation experiments the symbol rate was chosen as 50 Mbps, resulting in a rate across the Space Time Spreading simulator with two symbols being transmitted at the same time of 100 Mbps. Due to the fact that this would represent a very large bandwidth in an actual system, the actual symbol rate was changed to 1 Mbps in the simulation used to investigate adjacent MAI. The chip rate used was 128 times that used for the actual symbol rate. Every 32 symbols transmitted, the flat fading complex coefficients for each path were changed using a Rayleigh pdf with mean 1

and a uniformly distributed phase over 2π . The received power was normalized so that the expected SNR was achieved at the output of the STS decoder. The STS decoder was provided with perfect knowledge of the fading coefficients which allowed for formation of the exact representation of the H matrix over each channel period. This was used by the STS decoder to provide estimates of the transmitted symbols as described by Equation 4 in Section 2. The receive antenna was assumed to be equidistant from the transmit antennas, and that mean received power for both transmitters was the same.

After consideration of the delay through the simulated flat fading channels and with the addition of noise at both paths, validation experiments were performed as described in Section 4. These experiments used complex noise with zero mean. The variance of the complex noise was chosen dependent on whether one path ($m=1$) or two paths ($m=2$) were available. In this simulation orthogonal 128 length Walsh codes were used.

4.0 Validation of SIMULINK model

In [1] results were given for a BPSK system for implementations with a diversity of 1 and 2 for two transmit antenna. To emulate a system with a diversity gain of unity, one of the paths was given coefficients which had a magnitude of zero. The other path was allowed to vary with the Rayleigh pdf of unity mean and uniform distribution over 2π for the phase.

Exp. SNR (dB)	Lower 95% value	Average Mean BER	Upper 95% value
0	0.15580	0.15595	0.15610
2	0.11649	0.11666	0.11683
4	0.083535	0.083612	0.083688
6	0.0577641	0.0578706	0.0579770
8	0.0388098	0.0388938	0.0389778
10	0.0255275	0.0255871	0.0256467
12	0.0165672	0.0166182	0.01666929
14	0.0106397	0.0106858	0.01073188
16	0.0067820	0.0068267	0.00687146

Table 1: Measured values from $m=1$ Simulink simulation of Space Time Spreading System

The flat fading coefficients were perfectly reproduced at the receiver which was the case in

the corresponding data¹ provided in [1]. In addition, there was no multipath in the validation experiments, however this was the same assumption as for the data provided in [1].

The results for this simulation are provided with 95% confidence intervals in Table 1 and plotted as the $m=1$ curve in Figure 4. They are plotted with Bit Error Rates (BER) versus expected SNR as outlined in [1]. The complex gaussian noise added at the receiver for these results used a mean of zero and a variance for each of real and imaginary components of $1/\sqrt{2}$. The receiver then performs a hard decoding decision on the received bit streams. These results showed very close agreement with the corresponding results in [1].

Further, the other path was allowed to follow the Rayleigh pdf of unity mean and a uniform distribution over 2π for the phase, again with perfect knowledge at the receiver of these flat fading coefficients. Once again there was no multipath within this simulation as was the case in [1]. The complex gaussian noise added at the receiver for these results used a mean of zero and a variance for each of real and imaginary components of $1/\sqrt{8}$. As shown in Figure 3, a hard decoding decision was made at the receiver. The results for these simulations with 95% confidence intervals are shown in Table 2 and are plotted for the $m=2$ case in Figure 4. Once again there was very close agreement with the corresponding results in [1].

5.0 Adjacent MAI

When sectoring is applied different but orthogonal codes would be used in each of the

Exp. SNR (dB)	Lower 95% value	Average Mean BER	Upper 95% value
0	0.1252665	0.125378	0.1254898
2	0.0831215	0.8322366	0.08332581
4	0.0502437	0.0503287	0.05041376
6	0.0276203	0.0276945	0.02776882
8	0.0139458	0.0139903	0.01403474
10	0.0065782	0.0066009	0.00662362
12	0.0029317	0.0029446	0.00295742
14	0.0012654	0.0012712	0.00127689
16	0.0005373	0.00054065	0.00054400

Table 2: Measured values from $m=2$ Simulink simulation of Space Time Spreading System

¹ The figure used for comparison was Figure 4 of [1].

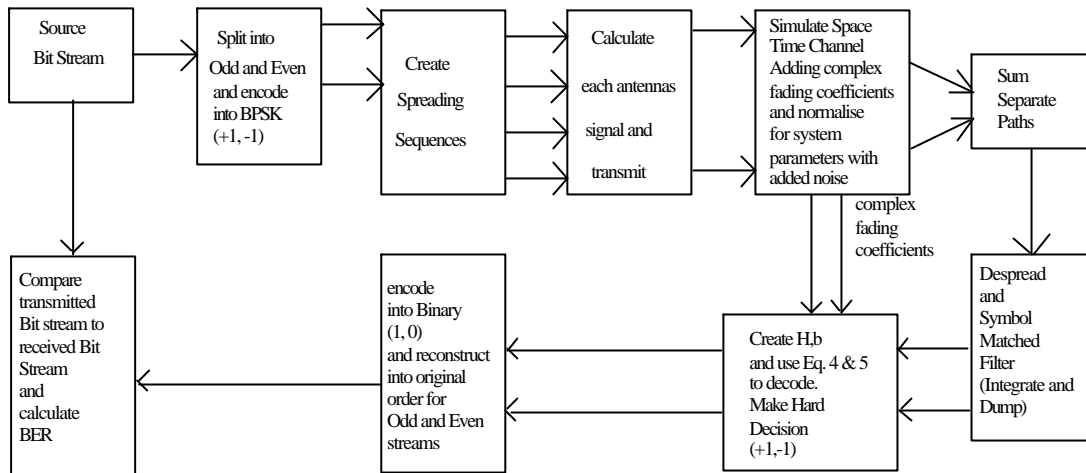

Space Time Spreading Simulink Model Functional Diagram

Figure 3: Simulink Model used in this study

sectors. When transmitted by a single antenna these codes would be synchronized and cause no MAI to different MS's in the sector. However, some signal could be deflected by scatterers in one sector to MS's in another sector. These scatterers could also move about causing the misalignment of otherwise orthogonal codes to occur. An example of moving objects may be a crowd of people in range of the sectorised BS or localized rain that falls in one sector but not in another. In this situation one or more multipath signals from one sector could impinge on the received signal experienced by another MS in another sector.

The interference following from this misalignment leads to Adjacent MAI errors in the received bit stream for the target MS in the Adjacent sector. Figure 5 shows a possible scenario for one multipath component that is deflected from one sector to another.

It is possible for the related interferer to have a signal power that is stronger to very much weaker than that transmitted by the BS in sector 1 under the following conditions:

- The distance between BS and Sector 1's Target MS is about 300 metres.
- Assuming that approximately one symbol period is the time taken normally for a signal to propagate from the BS to target MS.
- The multipath taken from sector two's scatterers to the Target MS in Sector 1 is less than approximately 900 metres.
- Assuming that power controls in adjacent sectors are not correlated.

Simple calculations based on this scenario and using a Bit rate of 1 Mbps per antenna pairing and considering the speed of light as being about 3×10^8 m/s reveals that the interfering signal can be unsynchronized with the Line of Sight signal from Sector 1's BS by a factor that varies between 0 and 127 chips, resulting in the MAI. Only when the signals are synchronized (zero chip variation) there will be no interference when using orthogonal code sets. The individual paths due to the two antenna transmitter in each Sector will have the same number of chip offset due to the distance and chip rate involved at 128 times the 1 Mbps rate of the symbol (a variation of $300/128 = 2.344$ metres). The validated Space Time Spreading simulator was modified to model an extra multipath received from a different user in another sector using two paths that will flow across a similar distance (in terms of chip periods). The target MS was set to experience an expected SNR of 0 and 4 dB. The interfering MS from the adjacent sector had its expected SNR varied between -5 dB's and 1 dB. The simulator was modified so that both signals were added together and then complex Gaussian noise was introduced as was done in the original validated models. Individual decoding stages decoded the streams for User 1 and User 2, but only User 1 is considered from the BER calculations. The flat fading complex coefficients were changed every 2346 symbols actually transmitted and the chip delay was varied every 18768 symbols transmitted. These numbers were chosen as they represent the Maximum Transmission Unit of a Medium Access Control (MAC) packet of a IEEE802.11 system for the chip delay variation and one eighth of this for the changing of the flat fading complex coefficients.

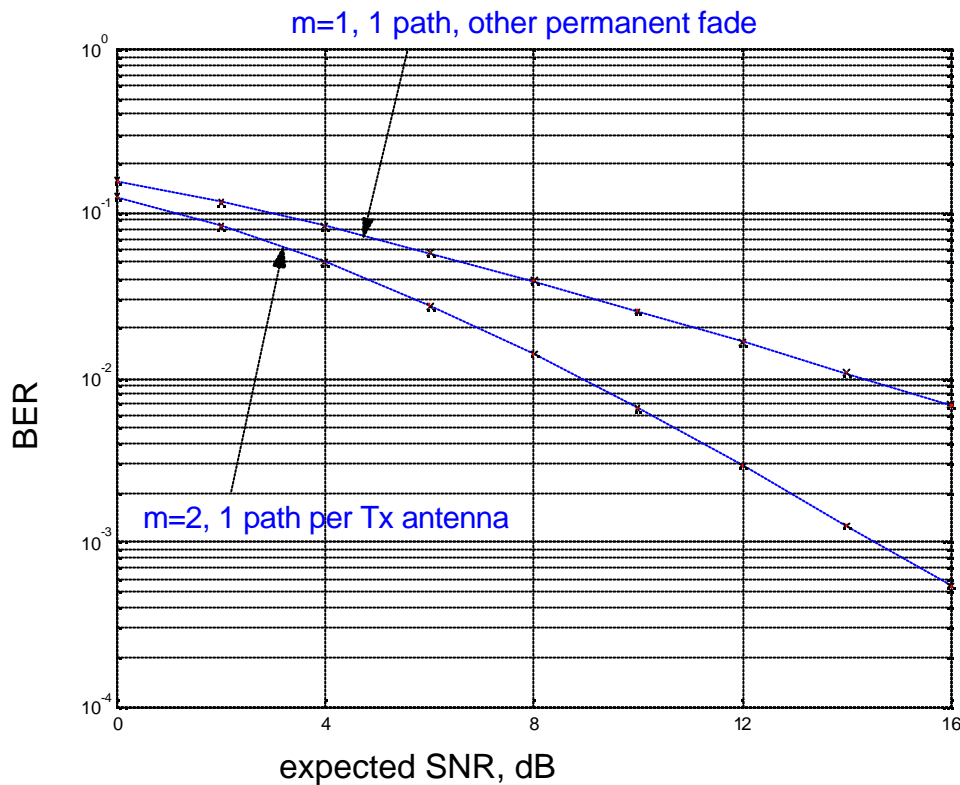

Figure 4: Plot for $m=1$ and $m=2$ with perfect knowledge of the flat fading complex coefficients and no multipath for BPSK system.

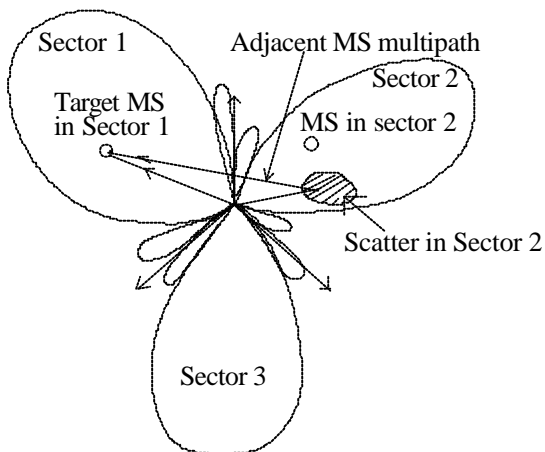

Figure 5: System with scatter in Sector 2 producing MAI in Sector 1

6.0 Effect of Adjacent MAI

The effects of adjacent MAI are shown in Figure 6 and Figure 7. In Figure 6 the target MS (called User 1) receives an expected SNR of 0 dB whereas in Figure 7 the same MS receives an expected SNR of 4 dB. The flat line in both graphs

shows the measured BER when no adjacent MAI is present. Clearly, in both Figure 6 and Figure 7 the presence of adjacent MAI increases the BER experienced by the target MS's received signal.

7.0 Conclusions

This study presented a simulation of a simple Space Time Spreading system. Validation of the developed model was achieved by simulating similar conditions to those studied in [1]. The simulation was then used to investigate how a Space Time Spreading system in adjacent sectors would behave in the presence of multipath from adjacent scatters. It was found that such multipath from adjacent sectors, called adjacent MAI, does in fact degrade the performance of Space Time Spreading systems. Further studies will include a mathematical analysis of the Space Time Spreading System in the presence of adjacent MAI. Also, it would be interesting to see the effect on the system if the adjacent MAI is limited to different chip variation segments (here chip variation was from 0 to 127 chips).

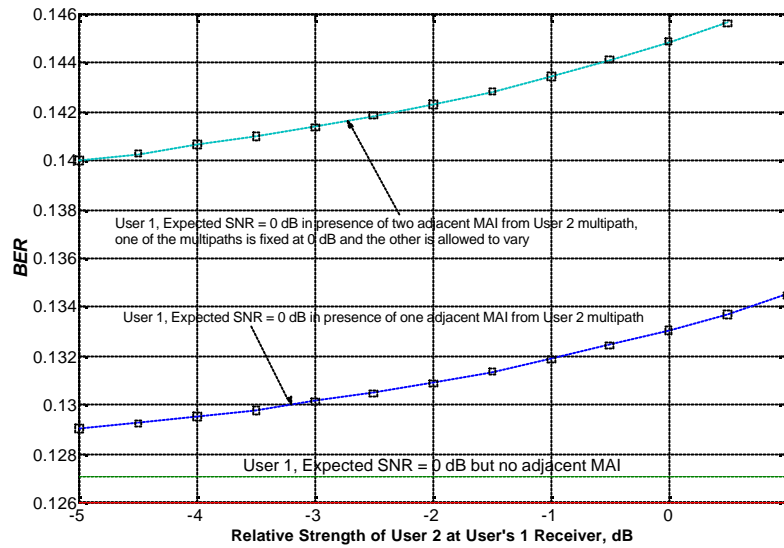

Figure 6: Effect of MAI on an adjacent sectors CDMA based user with User 1 received strength constant at 0 dB, User 2 signal varies

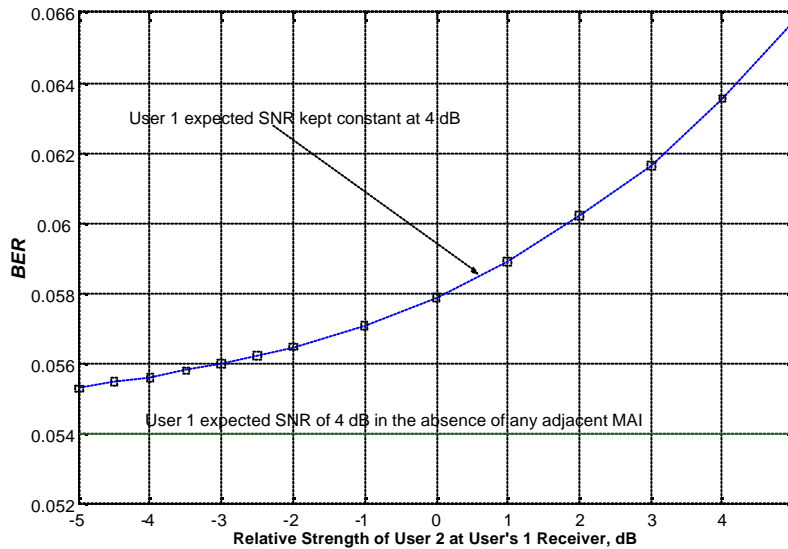

Figure 7: Effect of MAI on an adjacent sectors CDMA based user with User 1 received strength constant at 4 dB, User 2 signal varies

References

- Bertrand Hochwald, Thomas L Marzetta, Constantinos B Papadias, "A Transmitter Diversity Scheme for Wideband CDMA Systems Based on Space-Time Spreading", IEEE Journal on selected areas in communications, Vol 19, No 1, January 2001, pp. 48-60
- J Fuhl, A F Molisch, E Bonek, "Unified channel model for mobile radio systems with smart antennas", IEE Proceedings – Radar, Sonar Navigation, Vol 145, No1 Feb 1998 pp. 32-41
- Pieter van Rooyen, Michiel Lotter, Danie van Wyk, "Space Time Processing for CDMA Mobile Communications", Kluwer Academic Publications, 2nd printing 2001
- Theodore S Rappaport, "Wireless Communications: Principles and Practice", Second Edition, Prentice Hall Communications and Emerging Technologies Series, 2002, Chapter 9
- Joseph C Liberti Jr, Theodore S Rappaport, "Smart Antennas for Wireless Communications: IS-95 and Third Generation CDMA Applications", Prentice Hall Communications Engineering and emerging technologies series, Theodore S Rappaport Series Editor